

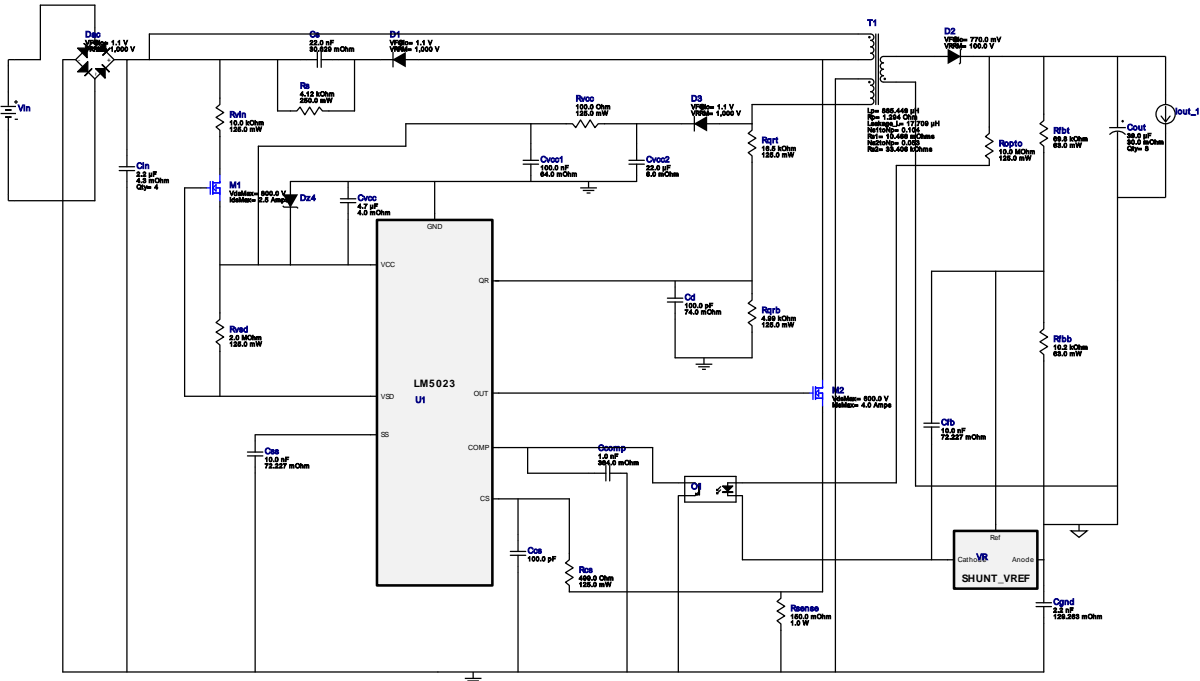









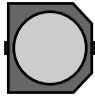



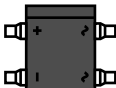

WEBENCH[®] Design Report

 Design : 1836019/16 LM5023MM-2/NOPB
 LM5023MM-2/NOPB 200.0V-220.0V to 19.57V @ 5.0A

1. Rbld is a starting point, but may need to be experimented with in order to get minimum current needed to hold Vout at no load. Rlc and the feedback resistors may also need adjustment based on the actual transformer used. For more information please click the design assistance button.

Electrical BOM

#	Name	Manufacturer	Part Number	Properties	Qty	Price	Footprint
1.	Ccomp	Kemet	C0805C102K5RACTU Series= X7R	Cap= 1.0 nF ESR= 384.0 mOhm VDC= 50.0 V IRMS= 214.0 mA	1	\$0.01	0805 7 mm ²
2.	Ccs	Kemet	C0201C101K3GACTU Series= C0G/NP0	Cap= 100.0 pF VDC= 10.0 V IRMS= 0.0 A	1	\$0.01	0201 2 mm ²
3.	Cd	Kemet	C0805C101J5GACTU Series= C0G/NP0	Cap= 100.0 pF ESR= 74.0 mOhm VDC= 50.0 V IRMS= 524.0 mA	1	\$0.01	0805 7 mm ²
4.	Cfb	TDK	C1005X7R1E103K Series= X7R	Cap= 10.0 nF ESR= 72.227 mOhm VDC= 25.0 V IRMS= 0.0 A	1	\$0.01	0402 3 mm ²
5.	Cgnd	TDK	C4532JB3D222K Series= 274	Cap= 2.2 nF ESR= 129.263 mOhm VDC= 2.0 kV IRMS= 0.0 A	1	\$0.21	1812 23 mm ²
6.	Cin	TDK	C5750X6S2W225K Series= 379	Cap= 2.2 uF ESR= 4.3 mOhm VDC= 400.0 V IRMS= 0.0 A	4	\$1.26	2220 54 mm ²

#	Name	Manufacturer	Part Number	Properties	Qty	Price	Footprint
7.	Cout	Panasonic	35SVPF39M Series= 1273	Cap= 39.0 uF ESR= 30.0 mOhm VDC= 35.0 V IRMS= 2.8 A	8	\$0.50	 CAPSMT_62_E7 106 mm ²
8.	Cs	TDK	C2012X7T2W223K Series= 480	Cap= 22.0 nF ESR= 30.629 mOhm VDC= 400.0 V IRMS= 0.0 A	1	\$0.05	 0805 7 mm ²
9.	Css	TDK	C1005X7R1E103K Series= X7R	Cap= 10.0 nF ESR= 72.227 mOhm VDC= 25.0 V IRMS= 0.0 A	1	\$0.01	 0402 3 mm ²
10.	Cvcc	MuRata	GRM21BR61E475KA12L Series= X5R	Cap= 4.7 uF ESR= 4.0 mOhm VDC= 25.0 V IRMS= 0.0 A	1	\$0.03	 0805 7 mm ²
11.	Cvcc1	Kemet	C0805C104K5RACTU Series= X7R	Cap= 100.0 nF ESR= 64.0 mOhm VDC= 50.0 V IRMS= 1.64 A	1	\$0.01	 0805 7 mm ²
12.	Cvcc2	MuRata	GRM31CR61C226ME15L Series= X5R	Cap= 22.0 uF ESR= 6.0 mOhm VDC= 16.0 V IRMS= 0.0 A	1	\$0.13	 1206 11 mm ²
13.	D1	Fairchild Semiconductor	1N4007	VF@Io= 1.1 V VRRM= 1,000.0 V	1	\$0.02	 DO-41 43 mm ²
14.	D2	Vishay-Semiconductor	50WQ10FNPBF	VF@Io= 770.0 mV VRRM= 100.0 V	1	\$0.41	 DPAK 102 mm ²
15.	D3	Fairchild Semiconductor	1N4007	VF@Io= 1.1 V VRRM= 1,000.0 V	1	\$0.02	 DO-41 43 mm ²
16.	Dac	Vishay-Semiconductor	DF10SA	VF@Io= 1.1 V VRRM= 1,000.0 V	1	\$0.24	 DF-S 99 mm ²
17.	Dz4	Diodes Inc.	MMSZ5246B-7-F	Zener	1	\$0.03	 SOD-123 13 mm ²
18.	M1	STMicroelectronics	STD3NK80ZT4	VdsMax= 800.0 V IdsMax= 2.5 Amps	1	\$0.46	 DPAK 102 mm ²
19.	M2	STMicroelectronics	STB4NK60ZT4	VdsMax= 600.0 V IdsMax= 4.0 Amps	1	\$0.53	 DDPAK 210 mm ²
20.	O1	California Eastern Laboratories	PS2811-1	Optocoupler	1	\$0.35	 SSOP-4 111 mm ²
21.	Rcs	Vishay-Dale	CRCW0805499RFKEA Series= CRCW..e3	Res= 499.0 Ohm Power= 125.0 mW Tolerance= 1.0%	1	\$0.01	 0805 7 mm ²
22.	Rfbb	Vishay-Dale	CRCW040210K2FKED Series= CRCW..e3	Res= 10.2 kOhm Power= 63.0 mW Tolerance= 1.0%	1	\$0.01	 0402 3 mm ²
23.	Rfbt	Vishay-Dale	CRCW040269K8FKED Series= CRCW..e3	Res= 69.8 kOhm Power= 63.0 mW Tolerance= 1.0%	1	\$0.01	 0402 3 mm ²

#	Name	Manufacturer	Part Number	Properties	Qty	Price	Footprint
24.	Ropto	Vishay-Dale	CRCW080510M0FKEA Series= CRCW..e3	Res= 10.0 MOhm Power= 125.0 mW Tolerance= 1.0%	1	\$0.01	 0805 7 mm ²
25.	Rqrb	Panasonic	ERJ-6ENF4991V Series= 225	Res= 4.99 kOhm Power= 125.0 mW Tolerance= 1.0%	1	\$0.01	 0805 7 mm ²
26.	Rqrt	Panasonic	ERJ-6ENF1652V Series= 225	Res= 16.5 kOhm Power= 125.0 mW Tolerance= 1.0%	1	\$0.01	 0805 7 mm ²
27.	Rs	Panasonic	ERJ-8ENF4121V Series= ERJ-8E	Res= 4.12 kOhm Power= 250.0 mW Tolerance= 1.0%	1	\$0.01	 1206 11 mm ²
28.	Rsense	Stackpole Electronics Inc	CSRN2010FKR150 Series= ?	Res= 150.0 mOhm Power= 1.0 W Tolerance= 1.0%	1	\$0.11	 2010 32 mm ²
29.	Rvcc	Vishay-Dale	CRCW0805100RFKEA Series= CRCW..e3	Res= 100.0 Ohm Power= 125.0 mW Tolerance= 1.0%	1	\$0.01	 0805 7 mm ²
30.	Rvin	Panasonic	ERJ-6ENF1002V Series= 225	Res= 10.0 kOhm Power= 125.0 mW Tolerance= 1.0%	1	\$0.01	 0805 7 mm ²
31.	Rvsd	Vishay-Dale	CRCW08052M00FKEA Series= CRCW..e3	Res= 2.0 MOhm Power= 125.0 mW Tolerance= 1.0%	1	\$0.01	 0805 7 mm ²
32.	T1	CUSTOM	CUSTOM	Lp= 885.449 µH Rp= 1.294 Ohm Leakage_L= 17.709 µH Ns1toNp= 0.104 Rs1= 10.468 mOhms Ns2toNp= 0.053 Rs2= 33.406 kOhms	1	NA	CUSTOM 0 mm ²
33.	U1	Texas Instruments	LM5023MM-2/NOPB	Switcher	1	\$0.38	 MUA08A 24 mm ²
34.	VR	Texas Instruments	TL431AIDBVR	Voltage References	1	\$0.09	 R-PDSO-G3 16 mm ²

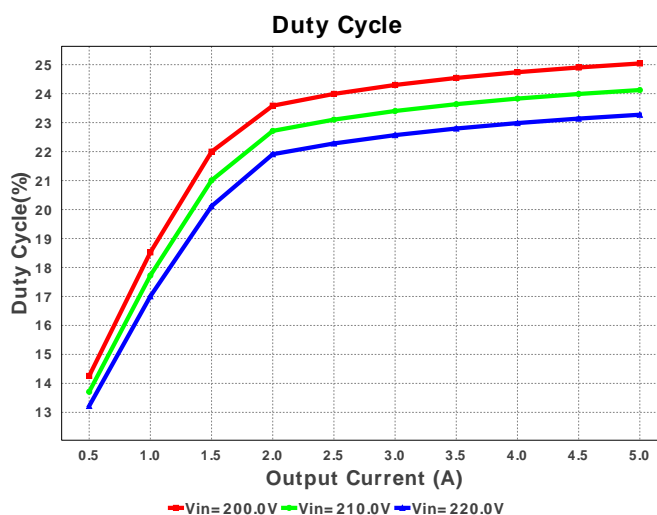
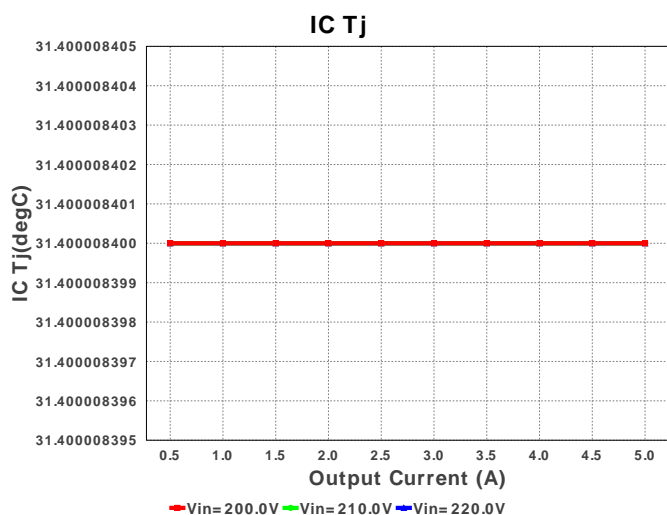

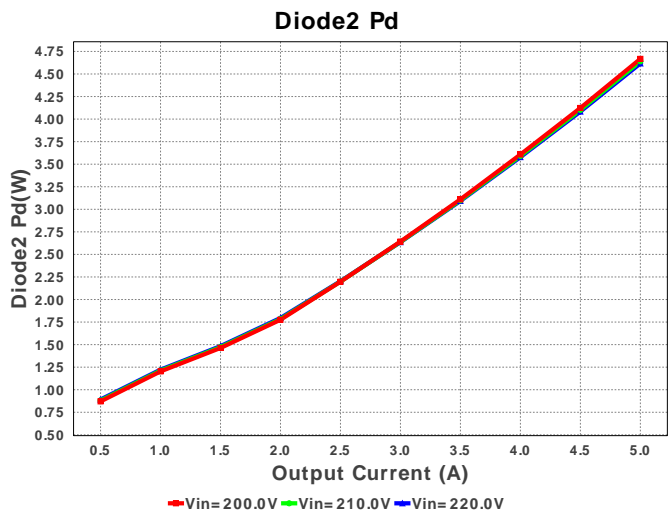
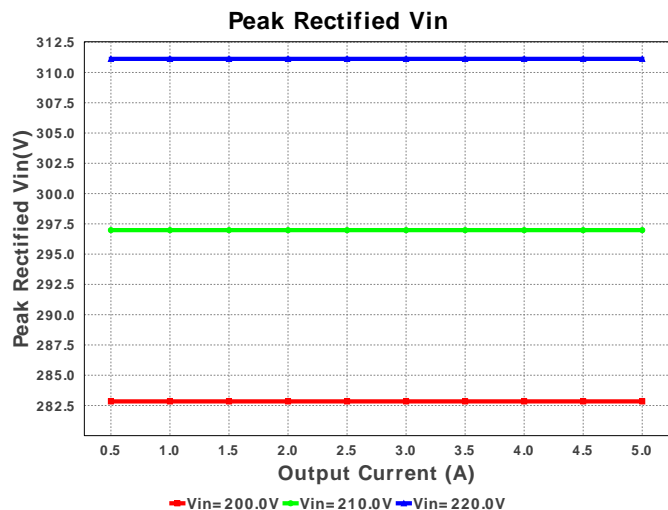
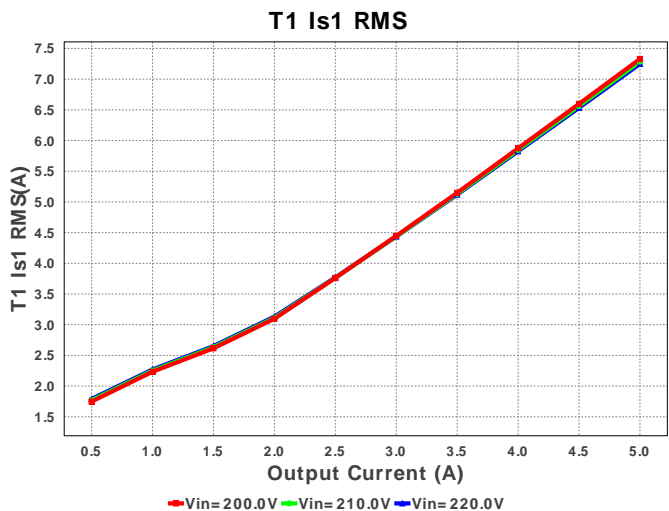
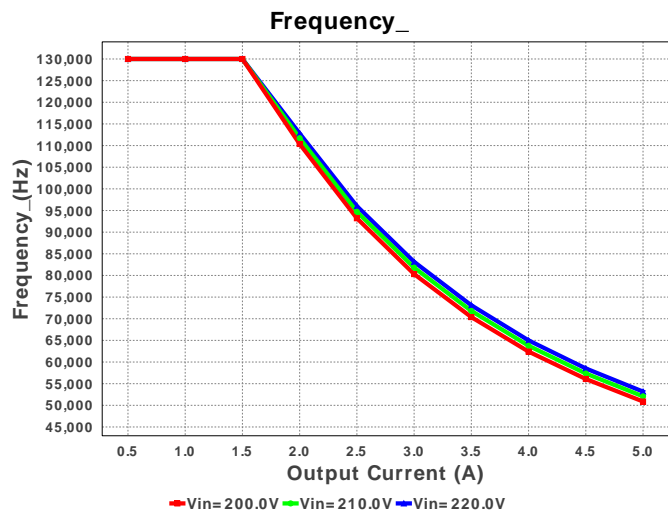
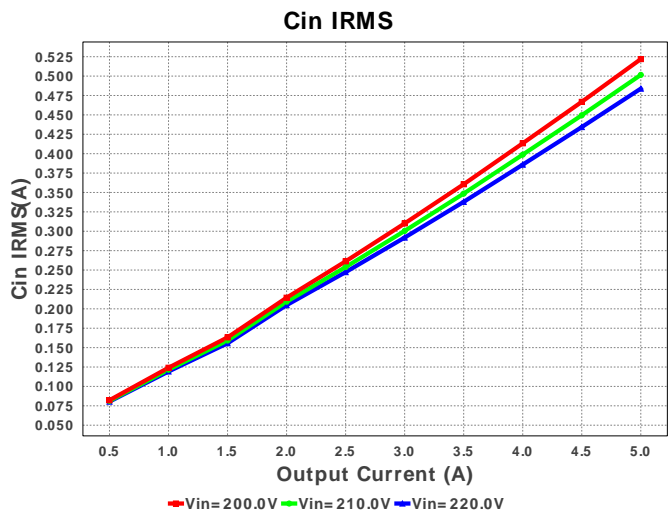
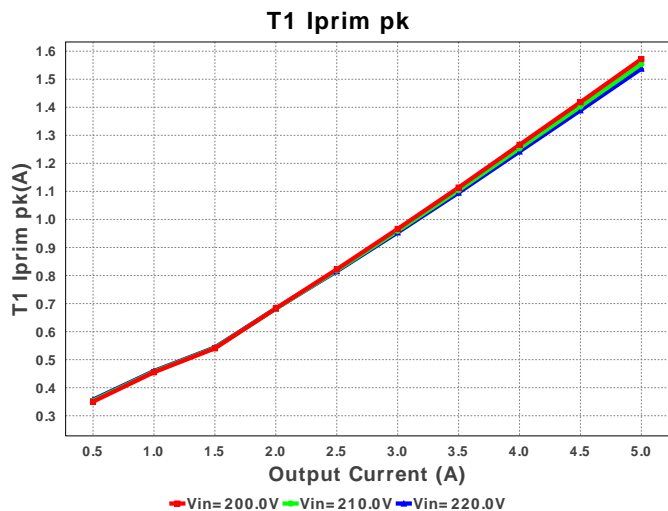

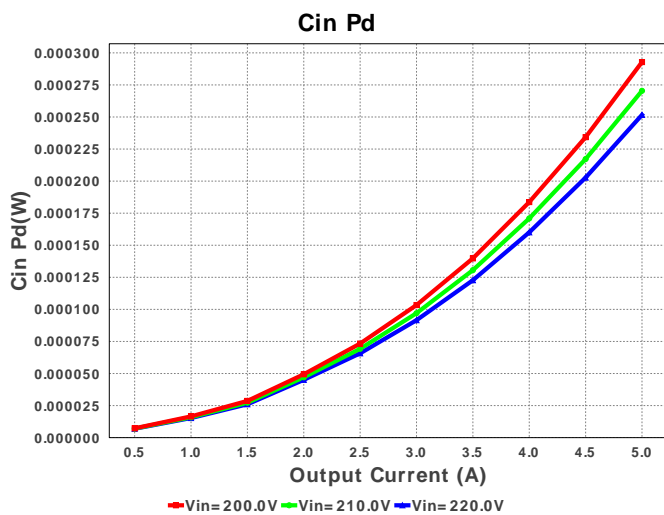
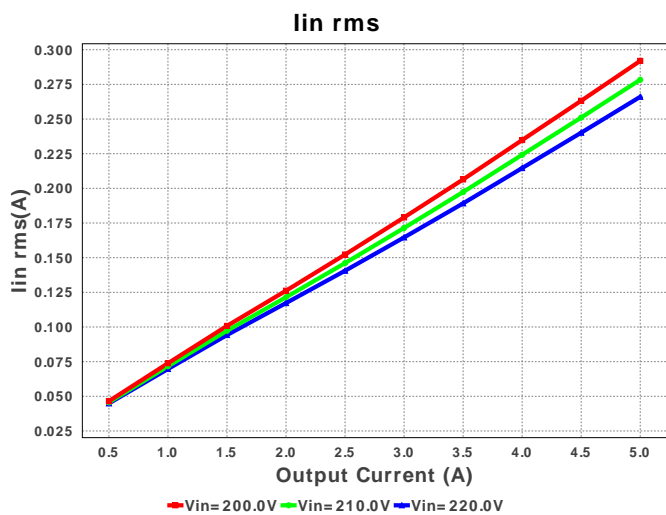
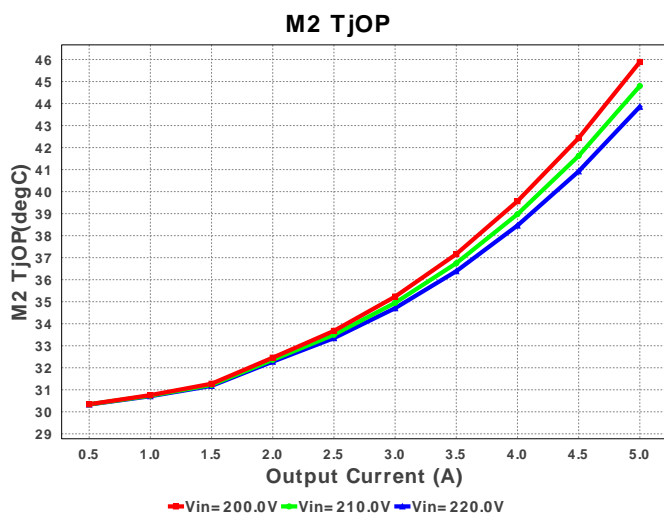
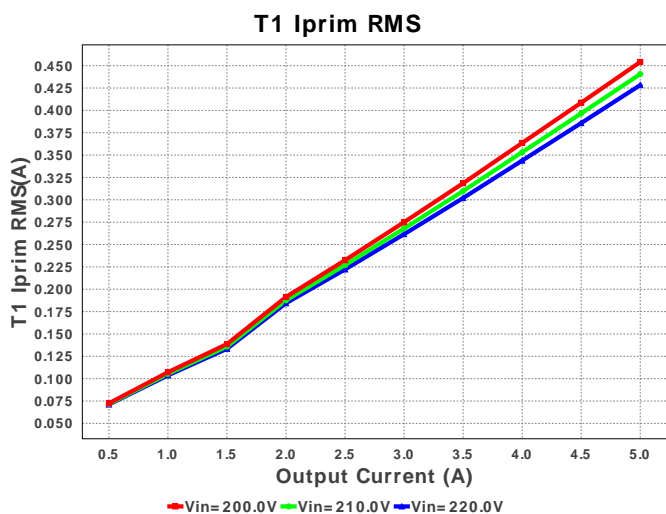
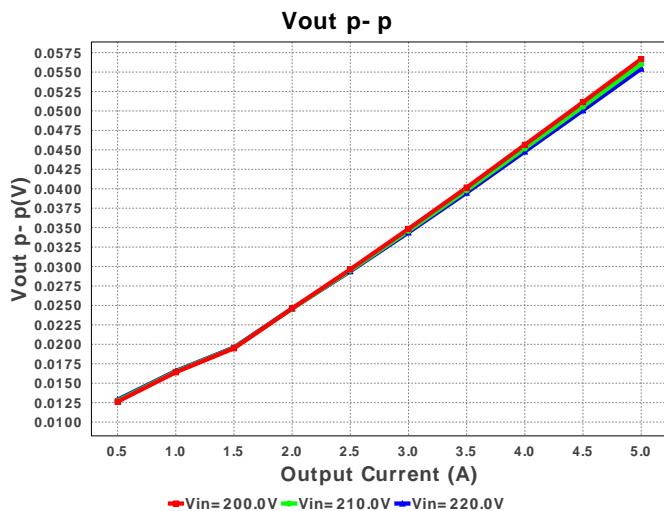
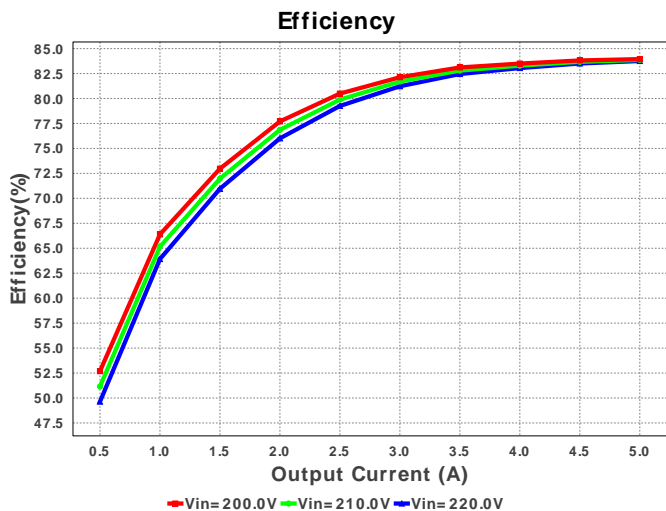

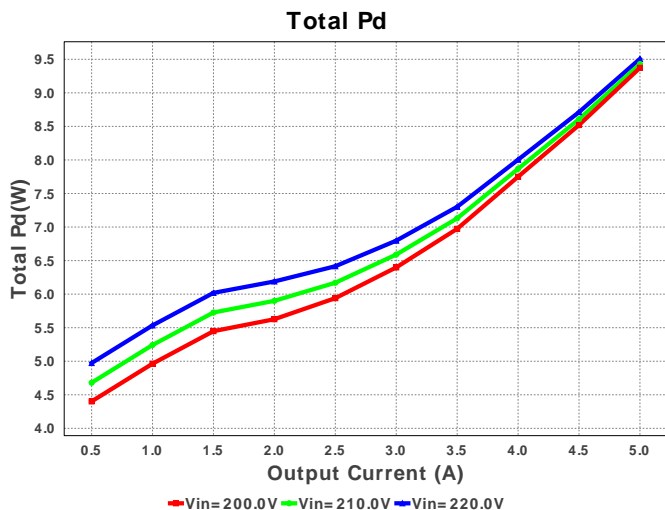
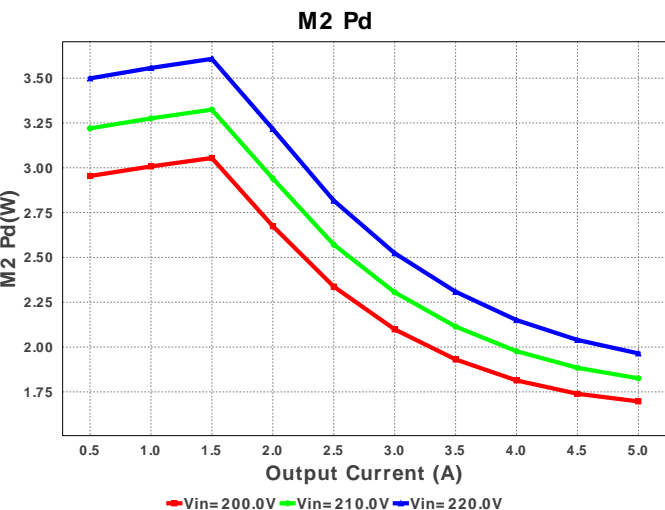
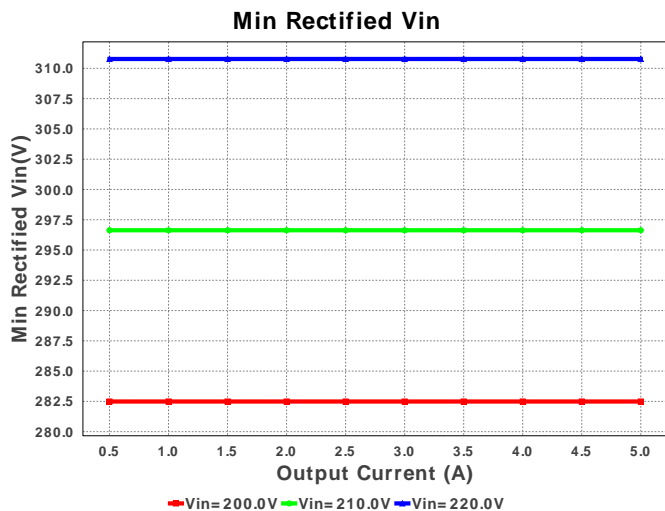
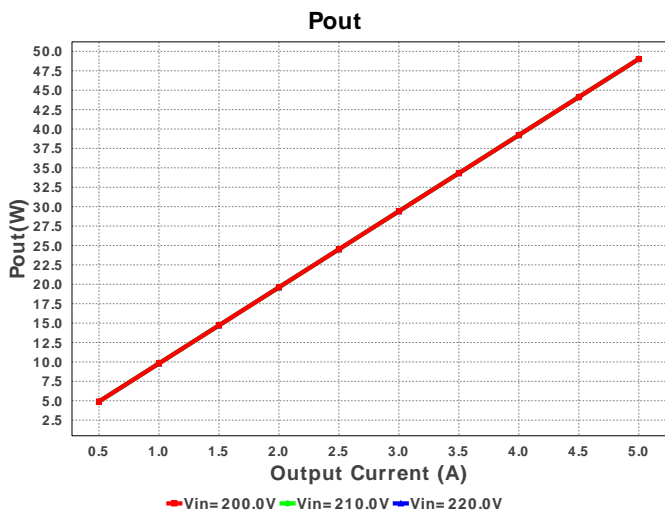
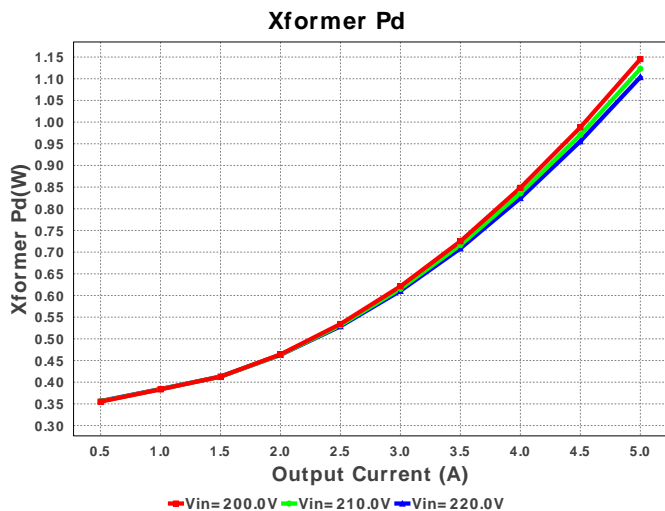
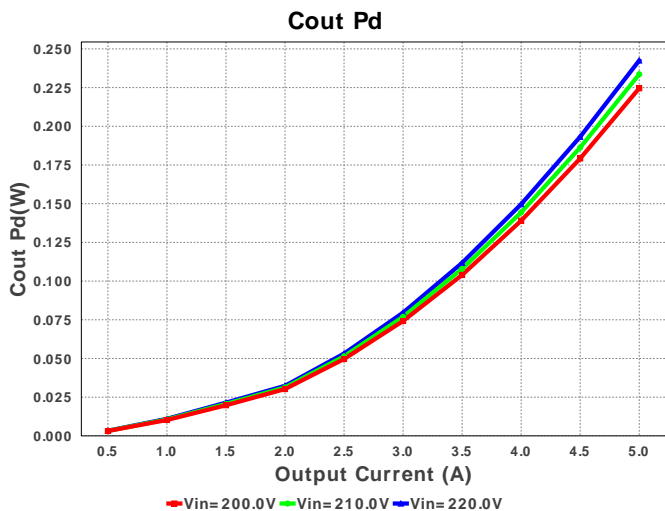

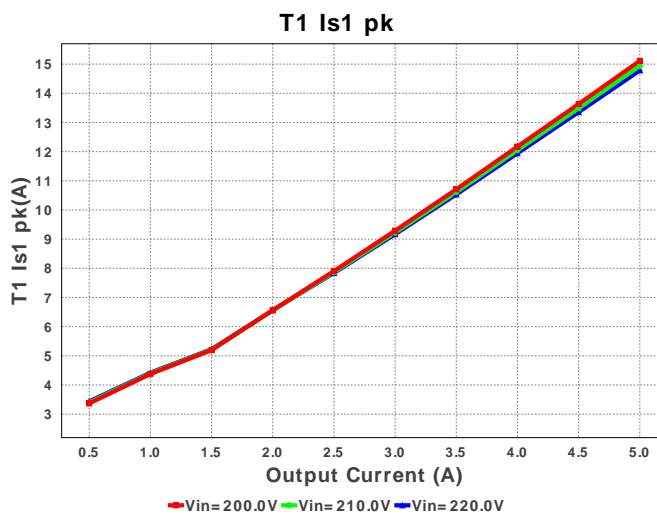
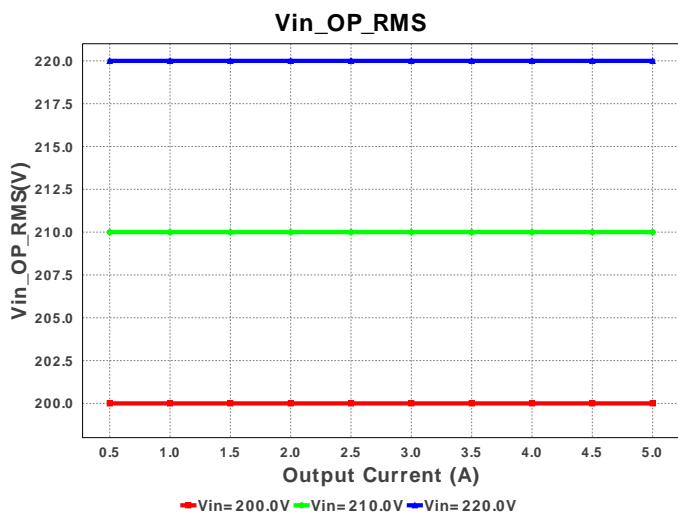
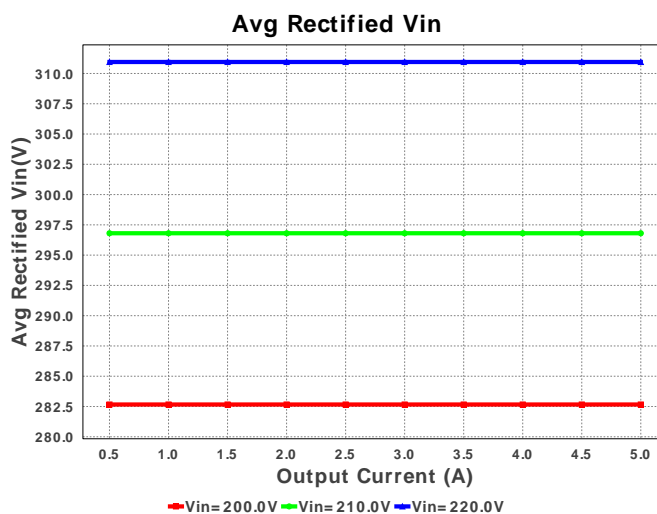
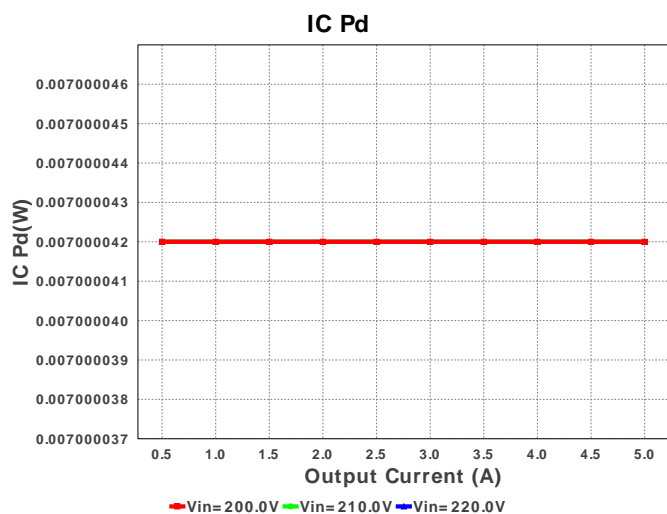
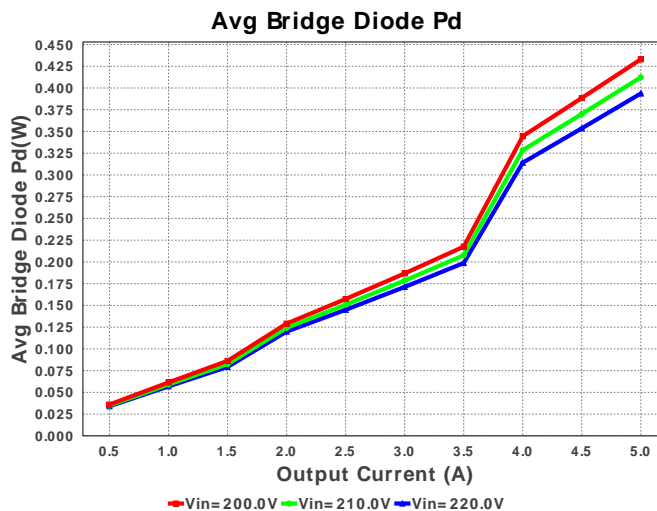
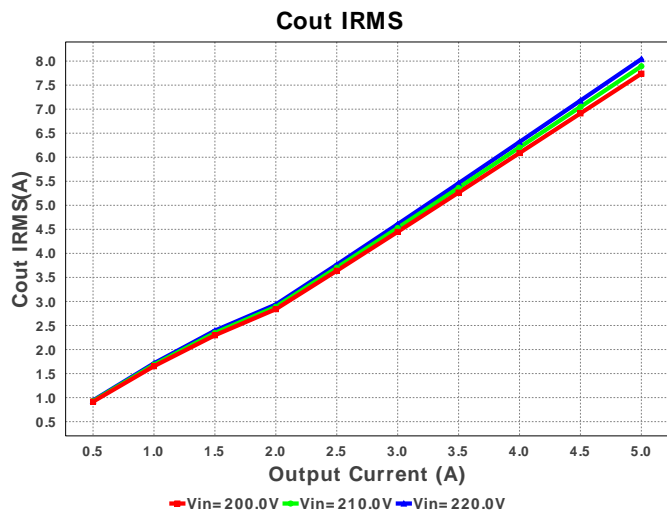

Operating Values

#	Name	Value	Category	Description
1.	Cin IRMS	907.072 mA	Current	Input capacitor RMS ripple current
2.	Cout IRMS	5.629 A	Current	Output capacitor RMS ripple current
3.	Iin rms	505.03 mA	Current	RMS Input Current
4.	T1 Iprim RMS	666.164 mA	Current	Transformer Primary RMS Current
5.	T1 Iprim pk	1.862 A	Current	Transformer Primary Peak Current
6.	T1 Is1 RMS	7.866 A	Current	Transformer Secondary1 RMS Current
7.	T1 Is1 pk	17.902 A	Current	Transformer Secondary1 Peak Current
8.	Avg Rectified Vin	310.949 V	General	Average Rectified Voltage for the AC Line Period
9.	BOM Count	44	General	Total Design BOM count
10.	FootPrint	2.004 k mm ²	General	Total Foot Print Area of BOM components
11.	Pout	97.843 W	General	Total output power

#	Name	Value	Category	Description
12.	Total BOM	\$0.0	General	Total BOM Cost
13.	Vout OP	19.569 V	Op_Point	Operational Output Voltage
14.	Duty Cycle	39.784 %	Op_point	Duty cycle
15.	Efficiency	88.062 %	Op_point	Steady state efficiency
16.	Frequency_	68.237 kHz	Op_point	Switching frequency
17.	IC Tj	32.219 degC	Op_point	IC junction temperature
18.	ICThetaJA	200.0 degC/W	Op_point	IC junction-to-ambient thermal resistance
19.	IOUT_OP	5.0 A	Op_point	Iout operating point
20.	M2 TjOP	73.123 degC	Op_point	M2 MOSFET junction temperature
21.	Min Rectified Vin	310.774 V	Op_point	Minimum voltage seen at rectified input
22.	Peak Rectified Vin	311.124 V	Op_point	Peak voltage seen at rectified input
23.	Vin_OP_RMS	220.0 V	Op_point	AC Input RMS Voltage
24.	Vout p-p	67.134 mV	Op_point	Peak-to-peak output ripple voltage
25.	Avg Bridge Diode Pd	562.714 mW	Power	Average Power Dissipation in the Bridge Diode over the AC Line Period
26.	Cin Pd	884.488 µW	Power	Input capacitor power dissipation
27.	Cout Pd	118.813 mW	Power	Output capacitor power dissipation
28.	Diode2 Pd	5.01 W	Power	Diode2 power dissipation
29.	IC Pd	11.094 mW	Power	IC power dissipation
30.	M2 Pd	3.392 W	Power	M2 MOSFET total power dissipation
31.	Total Pd	13.264 W	Power	Total Power Dissipation
32.	Xformer Pd	1.597 W	Power	Transformer power dissipation

Design Inputs

#	Name	Value	Description
1.	Iout	5.0	Maximum Output Current
2.	Iout1	5.0	Output Current #1
3.	VinMax	220.0	Maximum input voltage
4.	VinMin	200.0	Minimum input voltage
5.	Vout	19.5	Output Voltage
6.	Vout1	19.5	Output Voltage #1
7.	acFrequency	0.0	Light Output in Lumen
8.	base_pn	LM5023	Texas Instruments Base Part Number
9.	source	AC	Input Source Type
10.	ta	30.0	Ambient temperature

Design Assistance

1. The feedback resistors will set the output voltage of the circuit. The values chosen may need to be fine tuned based on the final Transformer turns ratios and the voltage across the output diode at close to zero current. Please see the datasheet for further design guidance. <http://www.ti.com/lit/ds/symlink/lm5023.pdf>

2. LM5023 Product Folder : <http://www.ti.com/product/LM5023> : contains the data sheet and other resources.

Texas Instruments' WEBENCH simulation tools attempt to recreate the performance of a substantially equivalent physical implementation of the design. Simulations are created using Texas Instruments' published specifications as well as the published specifications of other device manufacturers. While Texas Instruments does update this information periodically, this information may not be current at the time the simulation is built. Texas Instruments does not warrant the accuracy or completeness of the specifications or any information contained therein. Texas Instruments does not warrant that any designs or recommended parts will meet the specifications you entered, will be suitable for your application or fit for any particular purpose, or will operate as shown in the simulation in a physical implementation. Texas Instruments does not warrant that the designs are production worthy.

You should completely validate and test your design implementation to confirm the system functionality for your application prior to production.

Use of Texas Instruments' WEBENCH simulation tools is subject to [Texas Instruments' Site Terms and Conditions of Use](#). Prototype boards based on WEBENCH created designs are provided AS IS without warranty of any kind for evaluation and testing purposes and are subject to the terms of the [Evaluation License Agreement](#).