

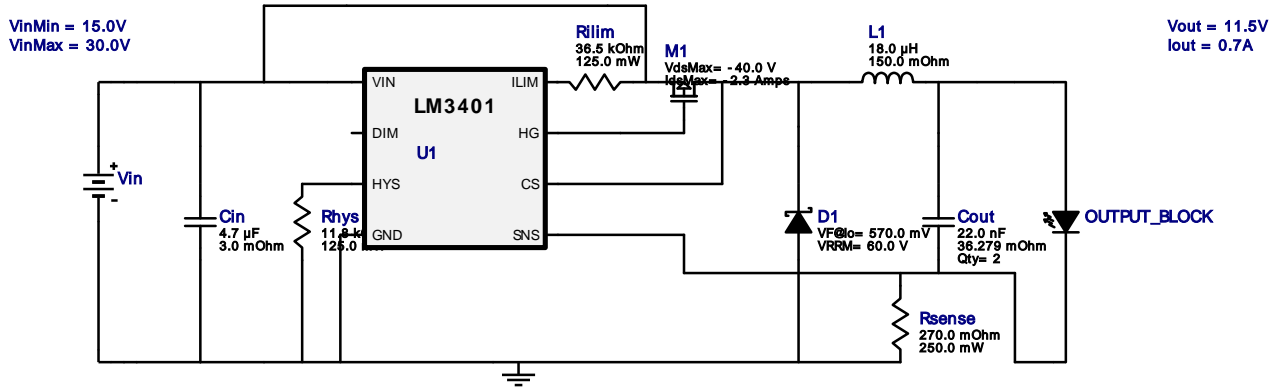





**WEBENCH® Design Report**

 Design : 3778301/12 LM3401MMX/NOPB  
 LM3401MMX/NOPB 15.0V-30.0V to 11.50V @ 0.7A

**Electrical BOM**

#	Name	Manufacturer	Part Number	Properties	Qty	Price	Footprint
1.	Cin	MuRata	GRM31CR71H475KA12L Series= X7R	Cap= 4.7 uF ESR= 3.0 mOhm VDC= 50.0 V IRMS= 4.98 A	1	\$0.07	 1206 11 mm <sup>2</sup>
2.	Cout	TDK	C1608X7R2A223K Series= X7R	Cap= 22.0 nF ESR= 36.279 mOhm VDC= 100.0 V IRMS= 0.0 A	2	\$0.01	 0603 5 mm <sup>2</sup>
3.	D1	NXP Semiconductor	PMEG6010CEH,115	VF@Io= 570.0 mV VRRM= 60.0 V	1	\$0.11	 SOD-123F 12 mm <sup>2</sup>
4.	D_LED	Cree	XHP50A-00-0000-0D00J40E1LED		1	\$6.54	 xlampxhp 0 mm <sup>2</sup>
5.	L1	Bourns	SDR0604-180YL	L= 18.0 uH DCR= 150.0 mOhm	1	\$0.18	 SDR0604 61 mm <sup>2</sup>
6.	M1	Vishay-Siliconix	SI2319DS-T1-E3	VdsMax= -40.0 V IdsMax= -2.3 Amps	1	\$0.28	 SOT-23 14 mm <sup>2</sup>
7.	Rhys	Panasonic	ERJ-6ENF1182V Series= ERJ-6E	Res= 11.8 kOhm Power= 125.0 mW Tolerance= 1.0%	1	\$0.01	 0805 7 mm <sup>2</sup>
8.	Rilim	Panasonic	ERJ-6ENF3652V Series= ERJ-6E	Res= 36.5 kOhm Power= 125.0 mW Tolerance= 1.0%	1	\$0.01	 0805 7 mm <sup>2</sup>
9.	Rsense	Panasonic	ERJ-8RQFR27V Series= ERJ-8R	Res= 270.0 mOhm Power= 250.0 mW Tolerance= 1.0%	1	\$0.04	 1206 11 mm <sup>2</sup>
10.	U1	Texas Instruments	LM3401MMX/NOPB	Switcher	1	\$0.60	 MUA08A 24 mm <sup>2</sup>

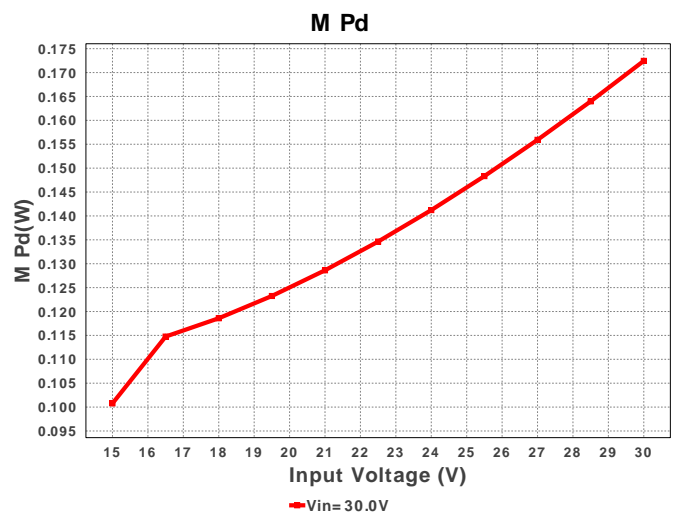
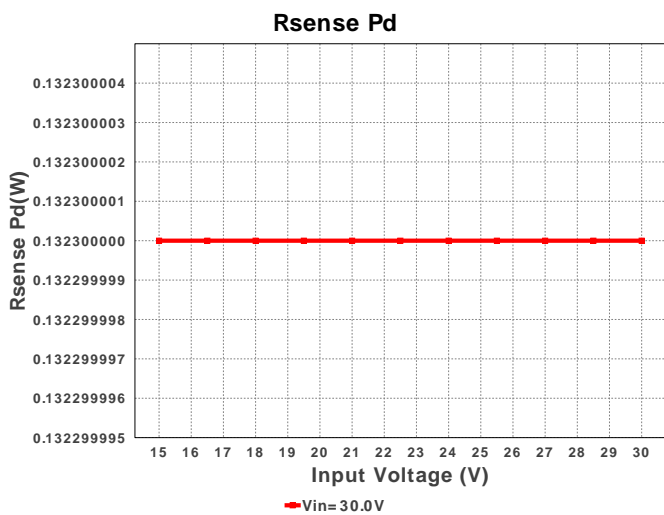
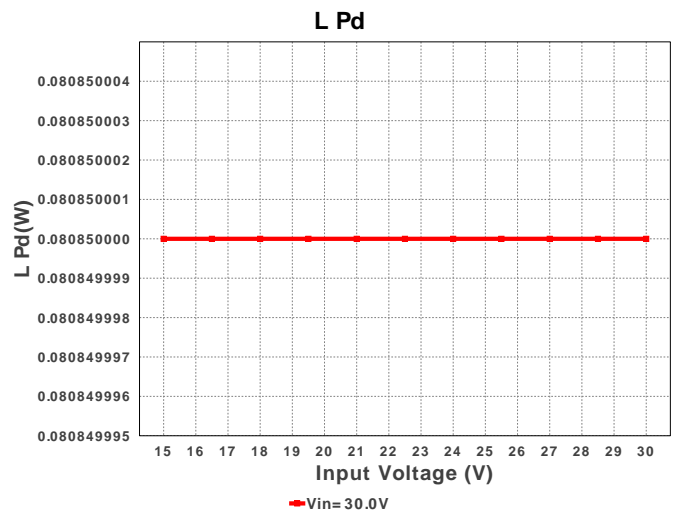
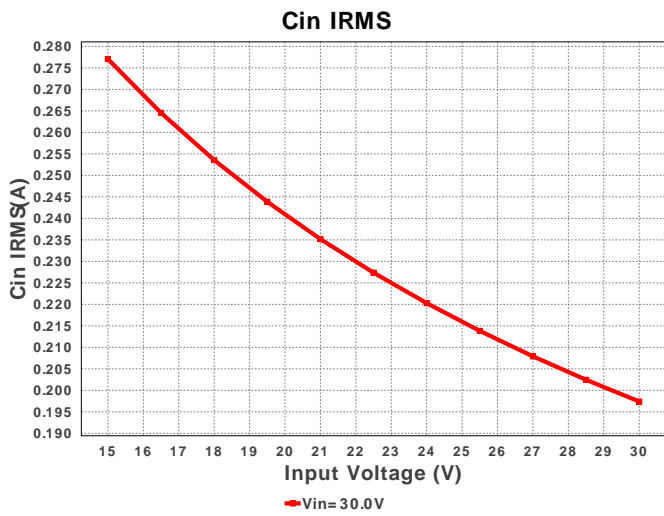
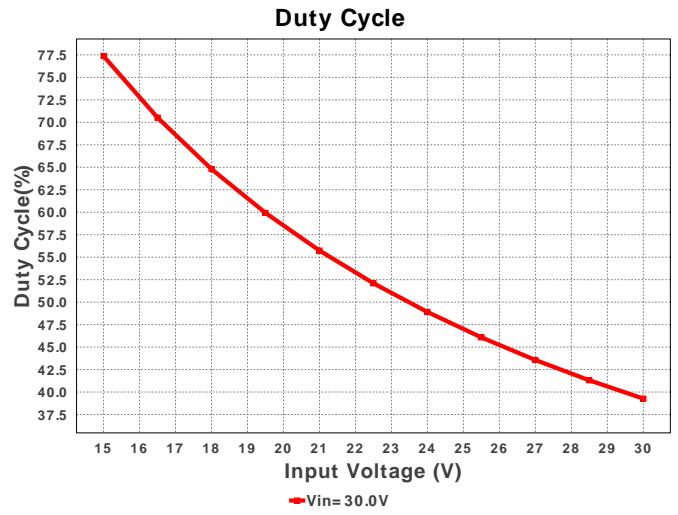
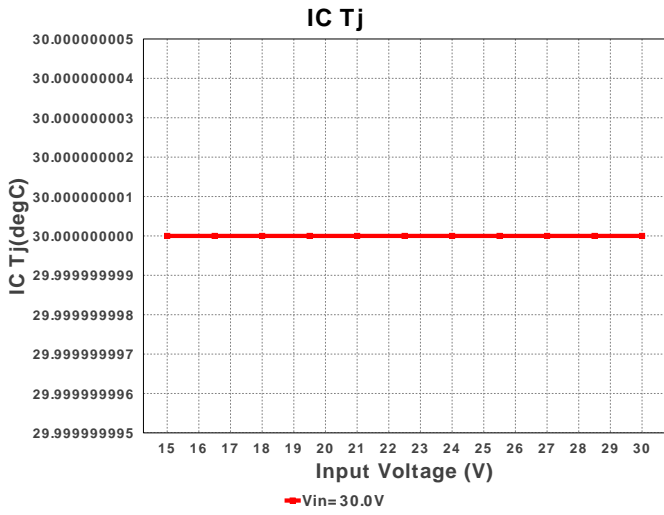
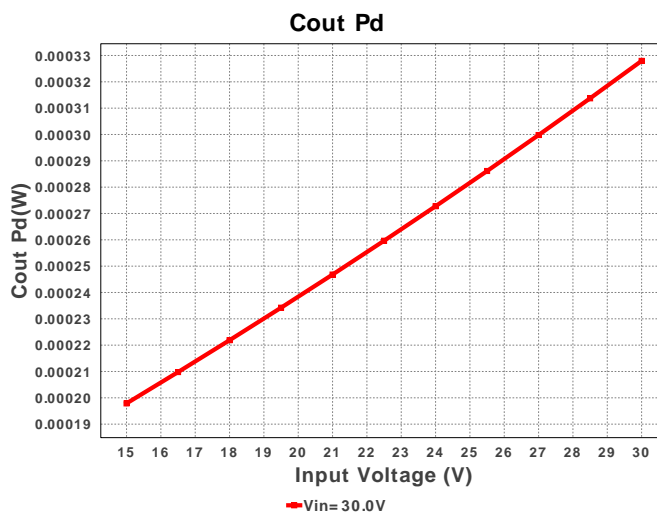
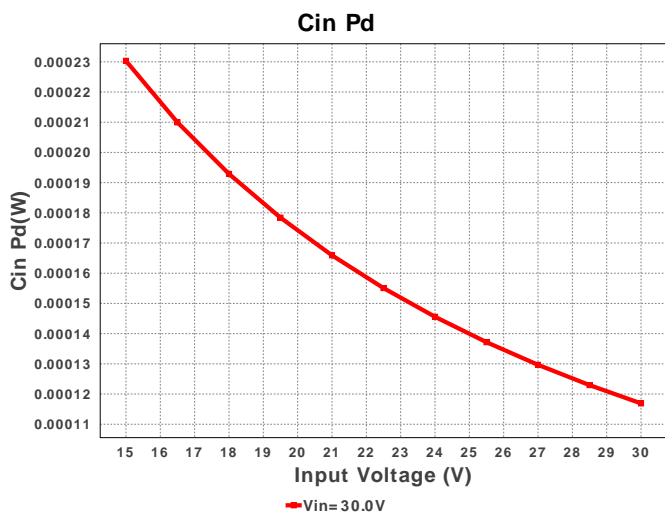
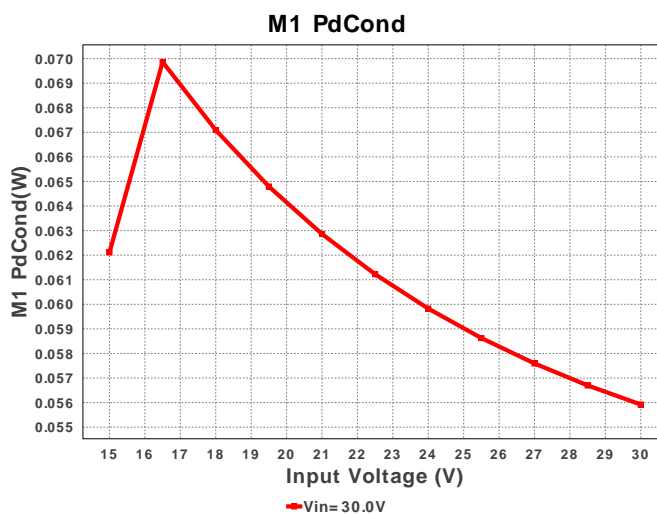
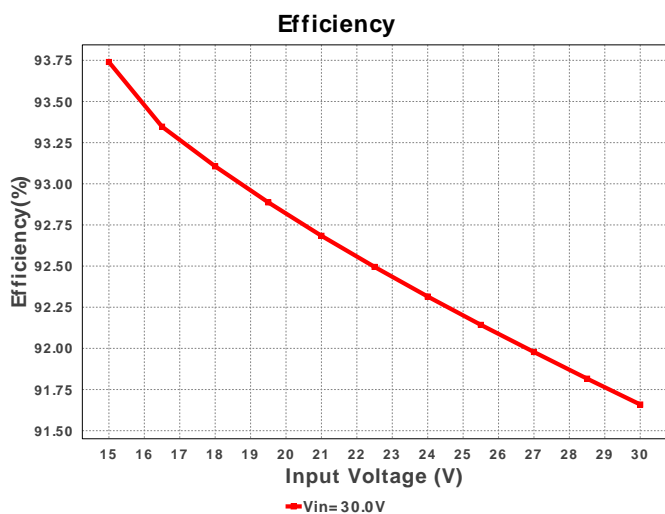
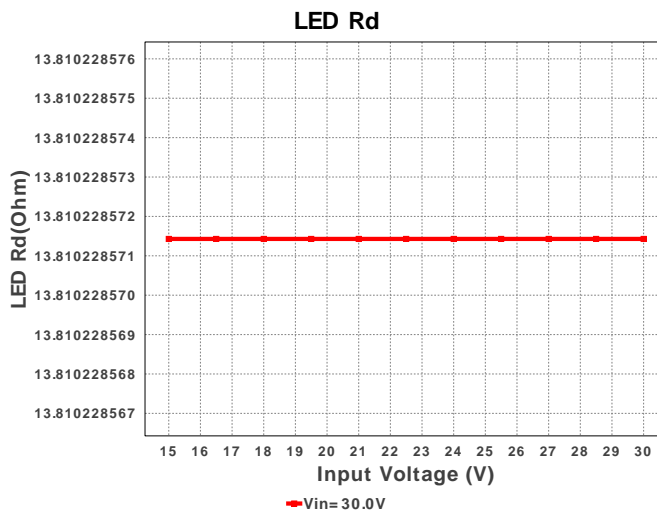
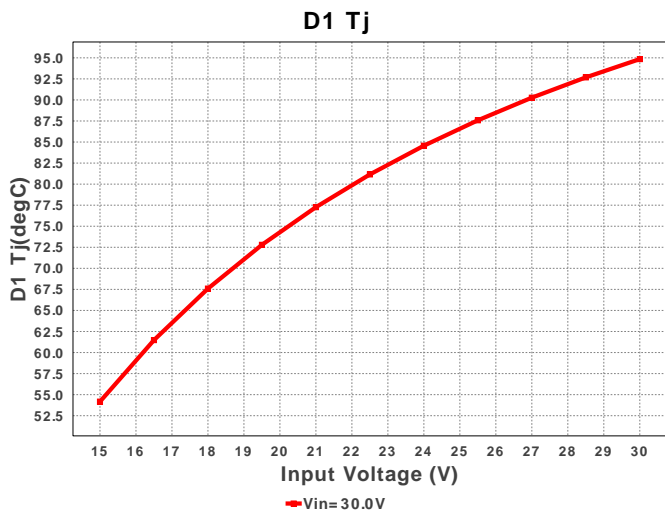

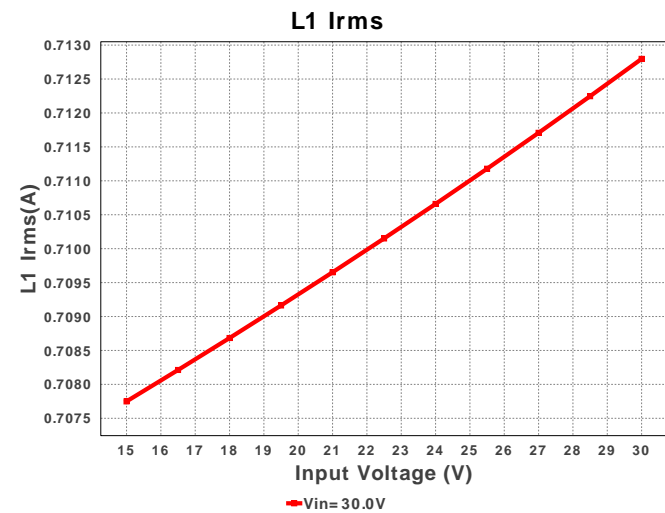
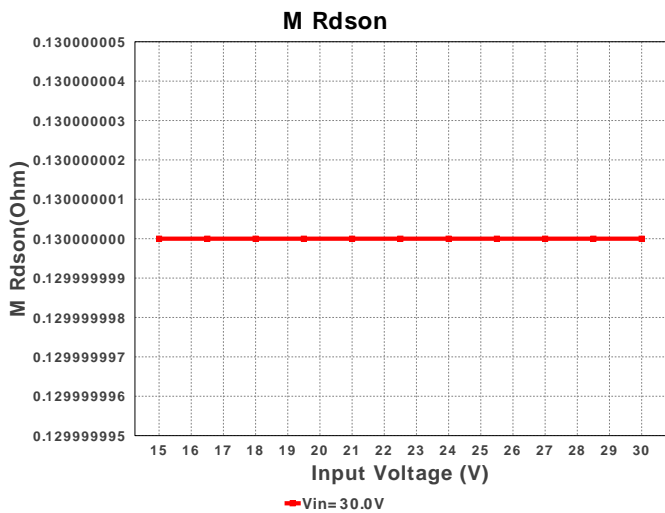
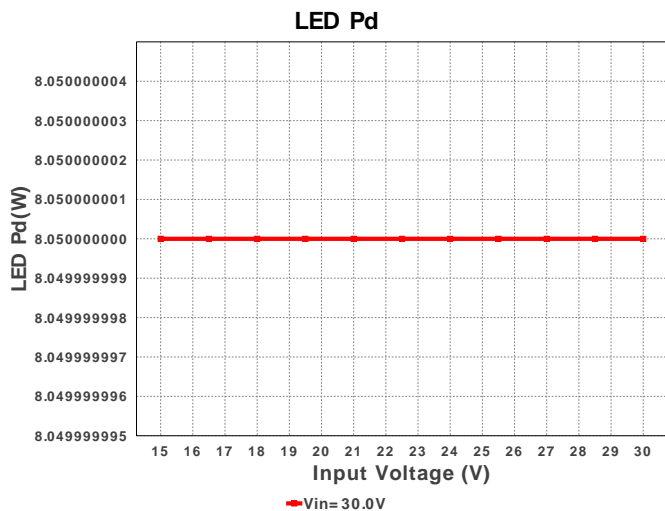
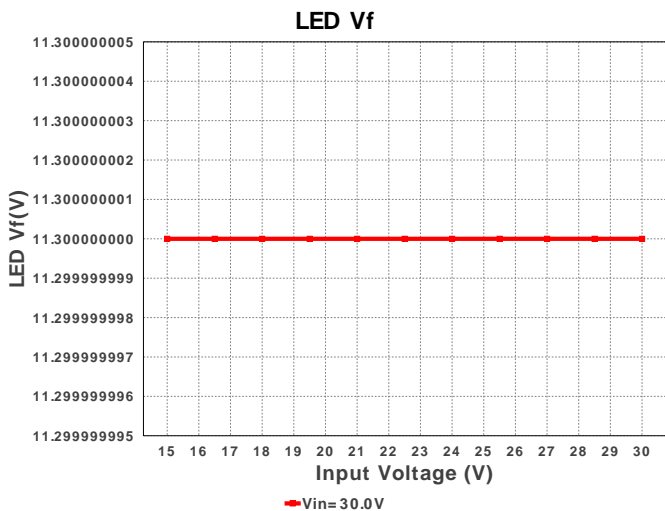
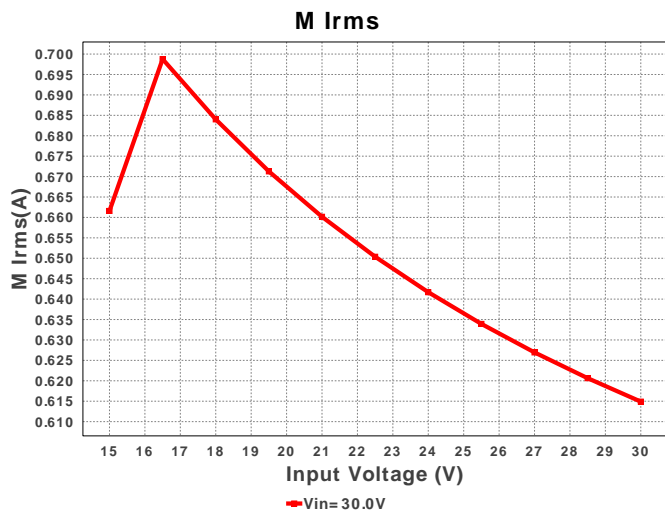
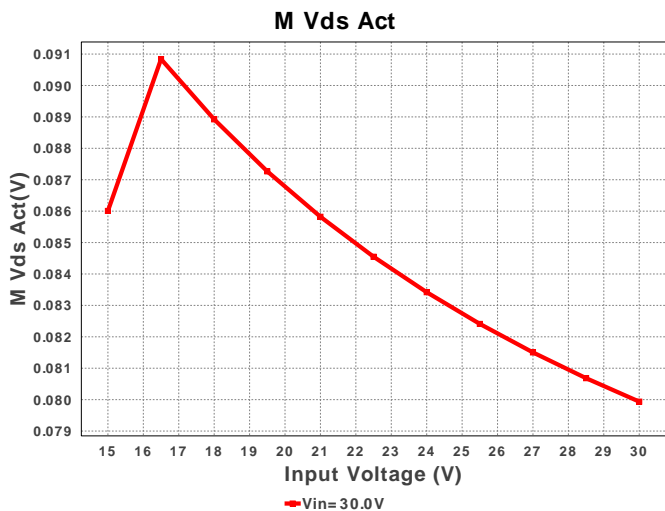

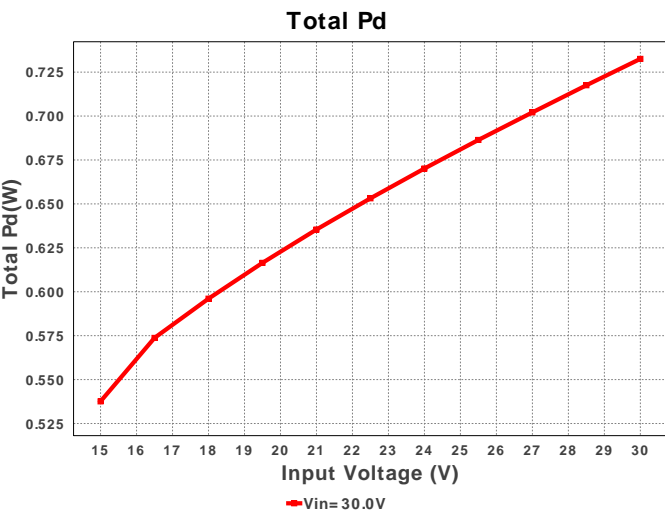
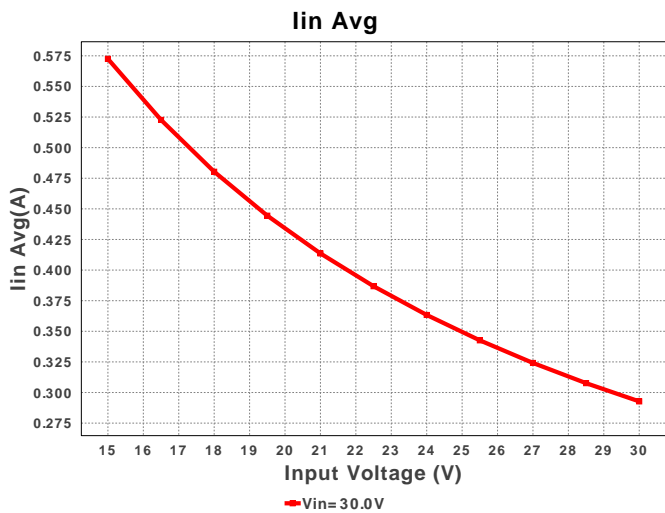
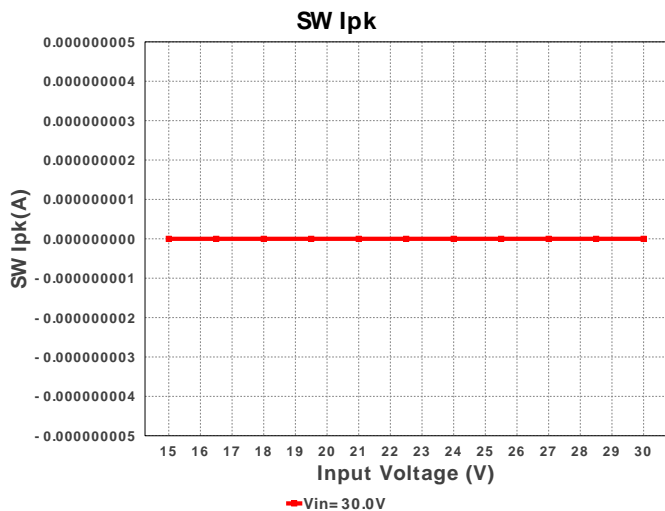
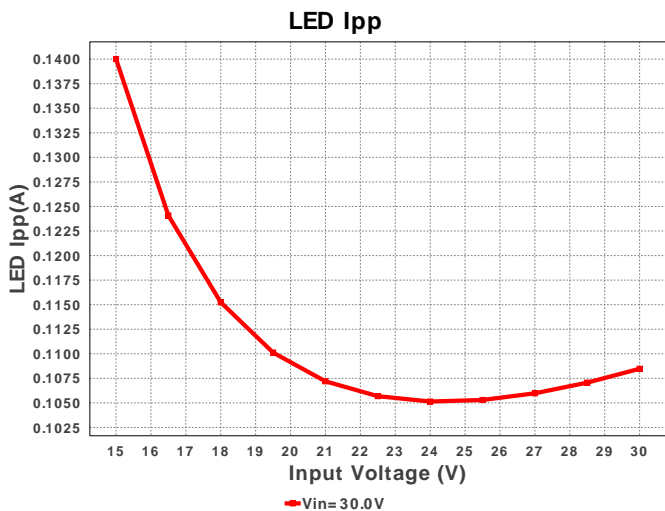
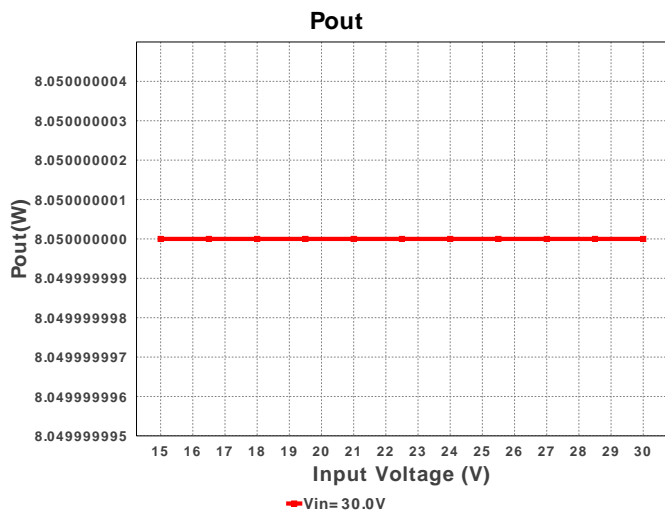
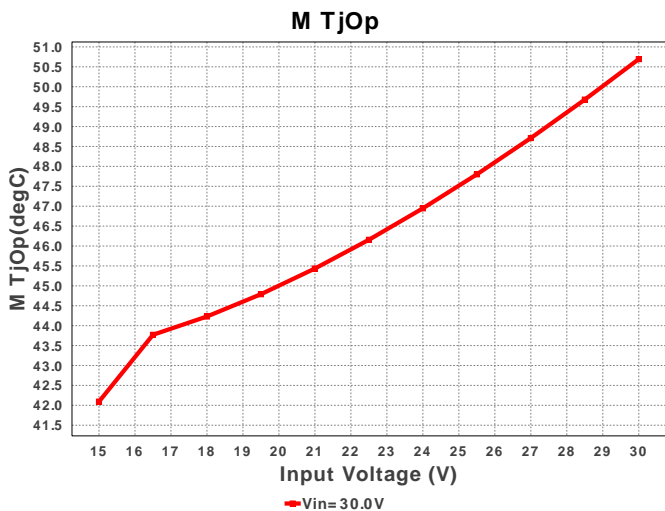



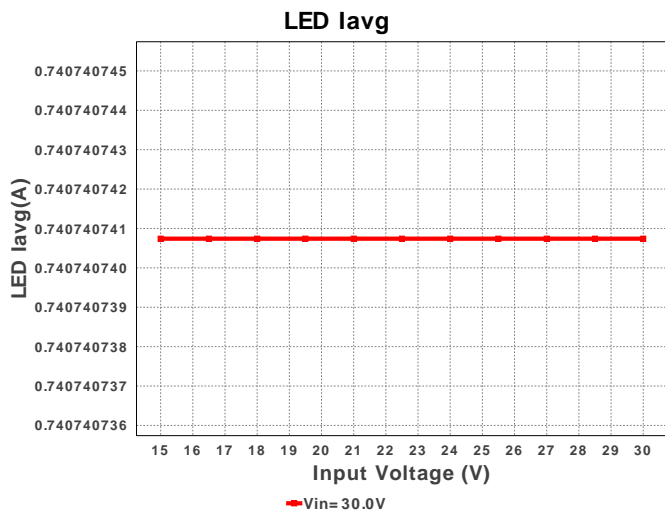
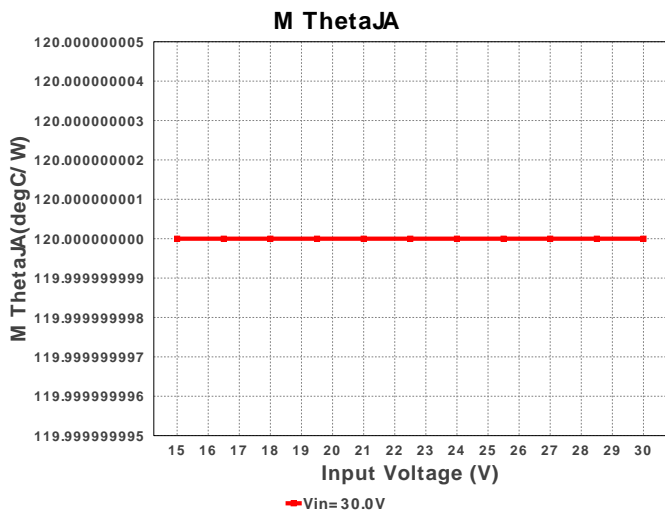
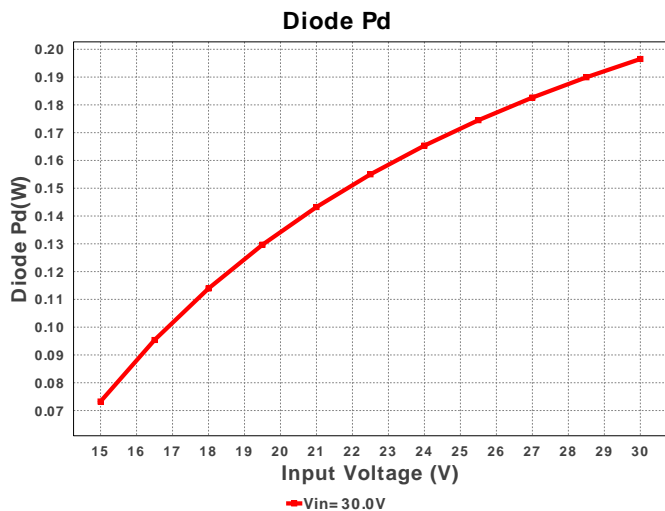
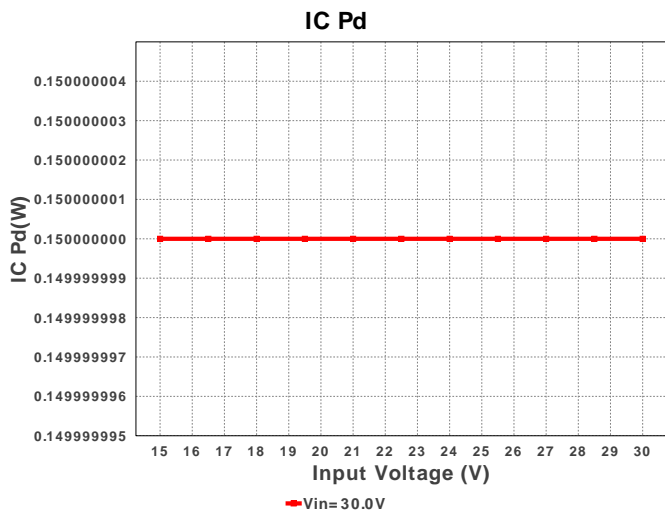
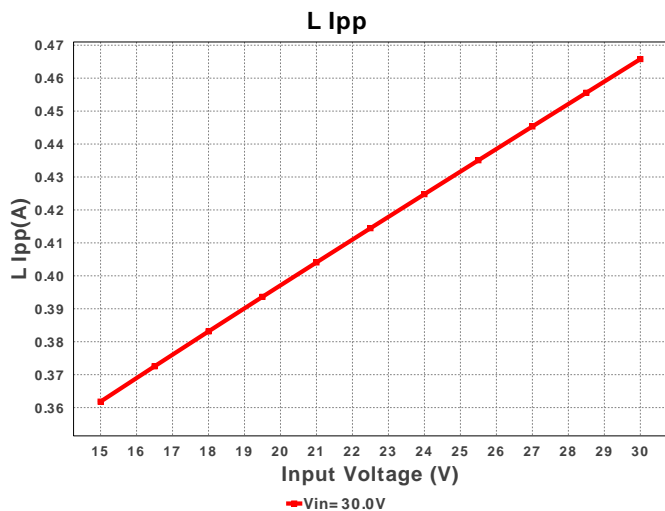
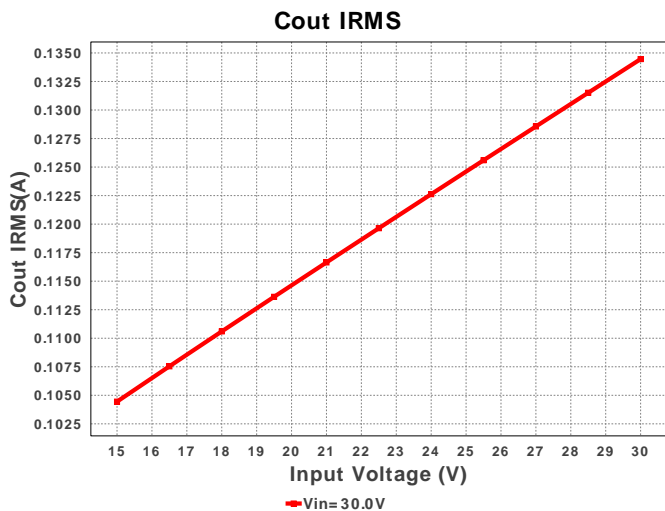

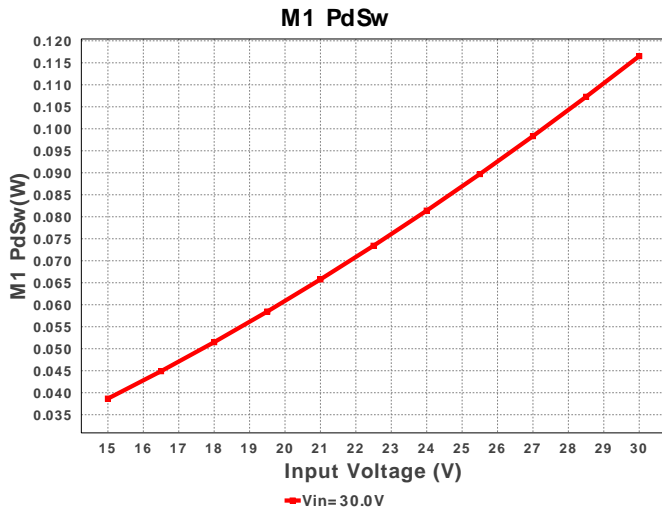

## Operating Values

#	Name	Value	Category	Description
1.	Cin IRMS	193.4 mA	Current	Input capacitor RMS ripple current
2.	Cout IRMS	133.683 mA	Current	Output capacitor RMS ripple current
3.	Iin Avg	296.87 mA	Current	Average input current
4.	L Ipp	463.09 mA	Current	Peak-to-peak inductor ripple current
5.	L1 Irms	712.651 mA	Current	Inductor ripple current
6.	LED Iavg	740.741 mA	Current	LED Average Current
7.	LED Ipp	107.045 mA	Current	LED Ripple Current
8.	M Irms	616.801 mA	Current	MOSFET RMS ripple current
9.	SW Ipk	0.0 A	Current	Peak switch current
10.	BOM Count	11	General	Total Design BOM count
11.	FootPrint	155.0 mm <sup>2</sup>	General	Total Foot Print Area of BOM components
12.	Frequency	875.0 kHz	General	Switching frequency
13.	IC Tolerance	12.0 mV	General	IC Feedback Tolerance
14.	M RdsOn	130.0 mOhm	General	Drain-Source On-resistance
15.	M Vds Act	80.184 mV	General	M Vds
16.	Pout	8.19 W	General	Total output power
17.	Total BOM	\$7.86	General	Total BOM Cost
18.	D1 Tj	89.346 degC	Op_Point	D1 junction temperature
19.	Vout OP	11.7 V	Op_Point	Operational Output Voltage
20.	Duty Cycle	39.856 %	Op_point	Duty cycle
21.	Efficiency	91.958 %	Op_point	Steady state efficiency
22.	IC Tj	30.0 degC	Op_point	IC junction temperature
23.	ICThetaJA	151.0 degC/W	Op_point	IC junction-to-ambient thermal resistance
24.	IOUT_OP	700.0 mA	Op_point	Iout operating point
25.	LED Rd	13.81 Ohm	Op_point	LED DynamicResistance
26.	LED Vf	11.5 V	Op_point	Total LED Forward Calculated Voltage
27.	M ThetaJA	120.0 degC/W	Op_point	MOSFET junction-to-ambient thermal resistance
28.	M TjOp	50.737 degC	Op_point	MOSFET junction temperature
29.	VIN_OP	30.0 V	Op_point	Vin operating point
30.	Cin Pd	112.211 μW	Power	Input capacitor power dissipation
31.	Cout Pd	324.176 μW	Power	Output capacitor power dissipation
32.	Diode Pd	179.837 mW	Power	Diode power dissipation
33.	IC Pd	150.0 mW	Power	IC power dissipation
34.	L Pd	80.85 mW	Power	Inductor power dissipation
35.	LED Pd	8.05 W	Power	LED Power Dissipation
36.	M Pd	172.806 mW	Power	MOSFET power dissipation
37.	M1 PdCond	56.28 mW	Power	M1 MOSFET conduction losses
38.	M1 PdSw	116.526 mW	Power	M1 MOSFET switching losses
39.	Rsense Pd	132.3 mW	Power	Rsense Power Dissipation
40.	Total Pd	716.229 mW	Power	Total Power Dissipation

## Design Inputs

#	Name	Value	Description
1.	Iout	700.0 m	Maximum Output Current
2.	Iout1	700.0 m	Output Current #1
3.	VinMax	30.0	Maximum input voltage
4.	VinMin	15.0	Minimum input voltage
5.	Vout	11.5	Output Voltage
6.	Vout1	11.5	Output Voltage #1
7.	application	LED_DRIVER	LED Application
8.	base_pn	LM3401	Texas Instruments Base Part Number

#	Name	Value	Description
9.	isLEDArchitect	N	LED Architect Project
10.	ledparallel	1.0	Number of LED in parallel
11.	ledpartnumber	XHP50A-00-0000-0D00141E	LED Part number
12.	ledseries	1.0	Number of LED in series
13.	line_fsw	60.0	AC Line Frequency
14.	source	DC	Input Source Type
15.	ta	30.0	Ambient temperature

## Design Assistance

1. LM3401 Product Folder : <http://www.ti.com/product/LM3401> : contains the data sheet and other resources.

Texas Instruments' WEBENCH simulation tools attempt to recreate the performance of a substantially equivalent physical implementation of the design. Simulations are created using Texas Instruments' published specifications as well as the published specifications of other device manufacturers. While Texas Instruments does update this information periodically, this information may not be current at the time the simulation is built. Texas Instruments does not warrant the accuracy or completeness of the specifications or any information contained therein. Texas Instruments does not warrant that any designs or recommended parts will meet the specifications you entered, will be suitable for your application or fit for any particular purpose, or will operate as shown in the simulation in a physical implementation. Texas Instruments does not warrant that the designs are production worthy.

**You should completely validate and test your design implementation to confirm the system functionality for your application prior to production.**

Use of Texas Instruments' WEBENCH simulation tools is subject to [Texas Instruments' Site Terms and Conditions of Use](#). Prototype boards based on WEBENCH created designs are provided AS IS without warranty of any kind for evaluation and testing purposes and are subject to the terms of the [Evaluation License Agreement](#).